

パーキングブロック (車止め)

(単位:mm)

NSP-A タイプ



※ネームシールは別途

NSP-120A 参考重量 25kg

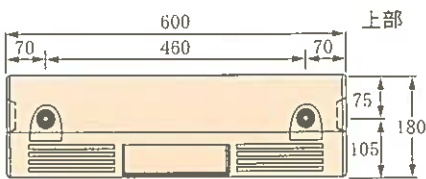

上部

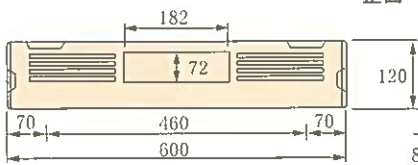

正面

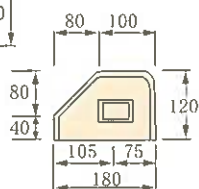

NSP-B タイプ



NSP-120B 参考重量 25kg

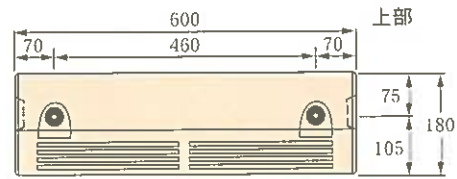

上部

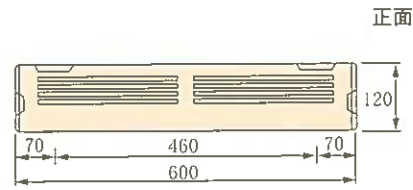

正面

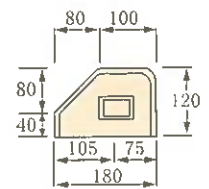

NSP-100A 参考重量 18kg

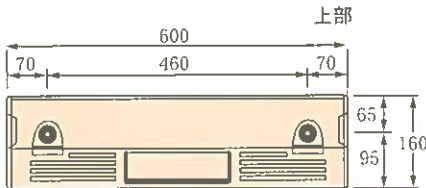

上部

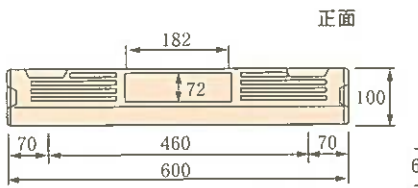

正面

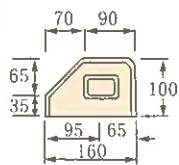

NSP-100B 参考重量 18kg

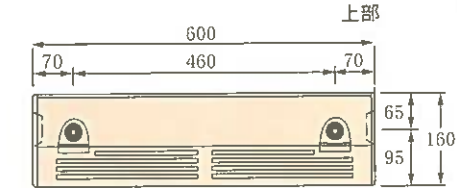

上部

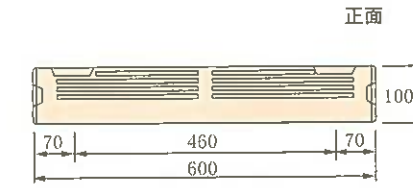

正面

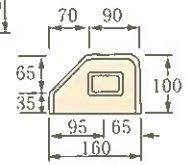

使用状態

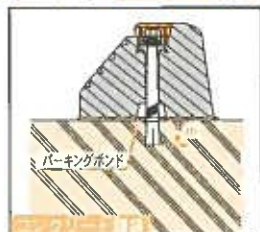
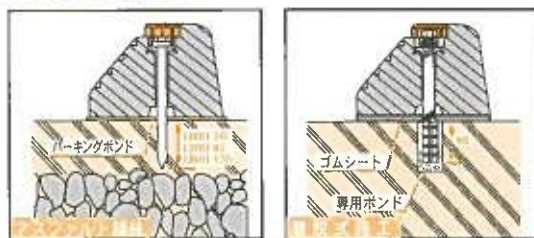

部材

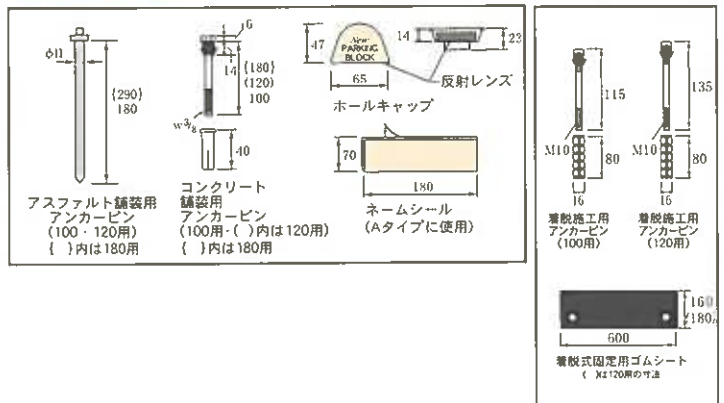

(単位:mm)

NSP-180B

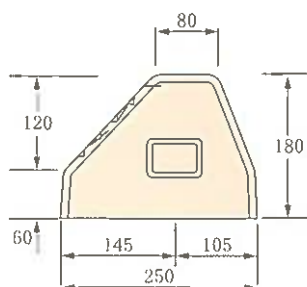
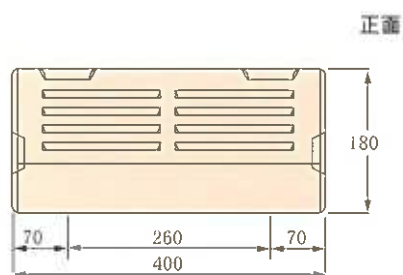
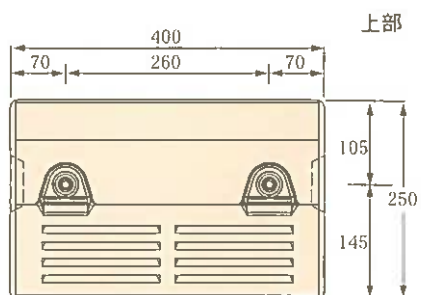

参考重量 32kg

碎石舗装用基礎版

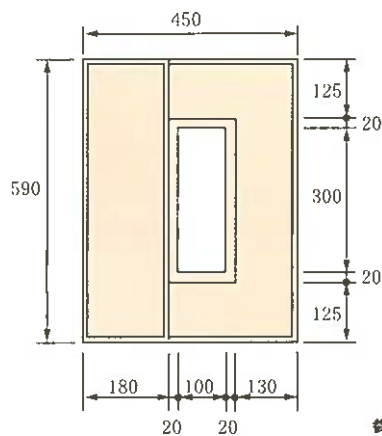
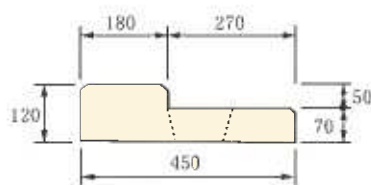

参考重量 50kg

緑石

使用状態

